

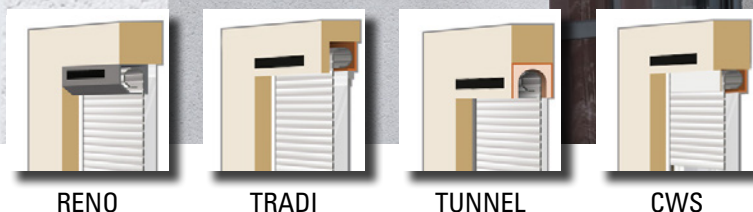

AUTONOMOUS
SOLAR SYSTEM

SOLAR MOTORIZATION

AUTOSUN 2



RENO

TRADI

TUNNEL

CWS



ACT FOR
GREEN

THE SOLAR SOLUTION 100% AUTONOMOUS, WITHOUT WORK

- **Autonomous motorization system** for roof and facade roller shutters, operating with solar energy, a **free, clean and renewable energy**.
- **No wiring:** AUTOSUN does not need to be connected neither to the electrical network nor to control points (SIMU-Hz radio technology), which means no degradation of interior walls.
- **Optimized outputs:** AUTOSUN has been designed to run in most geographical area.
- **Autonomy of the system: 45 days without sun, 2 cycles per day.**

- New motor, with more intelligence, for a simple integration and installation!
- A wide range of batteries.
- A new battery charger.
- Compatible with sequential & functional transmitters.

New DESIGN QUARTER ROUND:

to reduce needed space behind the guide rail or inside the roller shutter box.



THE SOLAR SOLUTION INCLUDES A MOTOR T3.5 E HZ DC, A SOLAR PANEL AND A BATTERY

MOTOR T3.5 E HZ DC



- Radio technology **simu-Hz** technology
- Adjustment of the end-limits: automatic, semi-automatic, manual
- STOP ON OBSTACLE function: the motor will stop during the closing if it meets an obstacle.
- FROST DETECTION function: the motor will stop during the opening if the shutter curtain is stuck in the guide rails by frost or if the bottom lath is locked.
- INTERMEDIARY POSITION: which can be adjusted to the user's need. Push "STOP" button of the transmitter to move the roller shutter to the favorite position.

- **Soft start function:** at DOWN end limit.
- **Soft stop function:** at UP & DOWN end limit.
- **Compatible with all SIMU-Hz transmitters and automatic devices,** including Hz sequential transmitter and Hz SUN sensor.
- **Adjustment of the end limit with reduced speed** in manual mode to ease the setting.
- **Motor Sleeping and Waking up modes are directly done from the transmitter,** no need to have access to the battery. The consumption is thus reduced to the minimum for storage or transportation of the roller shutter and the battery charge is then preserved. The motor will be woken up on site directly from the transmitter as well.
- **New motor cable** with 2 connectors 2 points and with mistake-proofing. Reduced size of the connectors to ease the integration inside the side frame.

REFERENCES

POWER SUPPLY 12 VDC

DESCRIPTION	TORQUE	SPEED	POWER	CURRENT	La	Lb	Lc	WEIGHT	REFERENCE		
									x1	x10	x100
T3,5 E Hz DC - 3/23	3Nm	23 rpm	17W	1.4A	437mm	459mm	474mm	0.77kg	2009080	2009083	2009086
T3,5 E Hz DC - 6/18	6Nm	18 rpm	26W	2.2A	437mm	459mm	474mm	0.8kg	2009081	2009084	2009087
T3,5 E Hz DC - 10/12	10Nm	12 rpm	30W	2.4A	437mm	459mm	474mm	0.8kg	2009082	2009085	2009088

TECHNICAL CHARACTERISTICS

NEW

- 2-point connector (male) for battery

- 2-point connector (female) for solar panel

2 holes Ø 3.1 x 10 mm for Ø 3.9 mm Plastite screws

La : Drilling dimensions of tubes.
Lb : Adapted motor size inside the tube.
Lc : Total motor length with adaptor.



- POWER SUPPLY** 12 Volts
- END-LIMIT** Electronic system with operating limited to 3 min.
- PROTECTION INDEX** IP 44
- POWER CABLE** Long. 0.2 meters, 3x0.75 mm² wires, white VVF with two connectors
- SIMU-Hz RADIO FREQUENCY** 433.42 MHz
- SECURE COMMUNICATION** Encrypted control orders
 - + Rolling code with 16 million possible combinations
- RANGE** ~200m in free field and ~20m through 2 reinforced concrete walls
- MOTOR HEAD THICKNESS** 14mm
- END-LIMIT ADJUSTMENT** every 60 cycles during 4 cycles



BATTERIES



2 different cable lengths

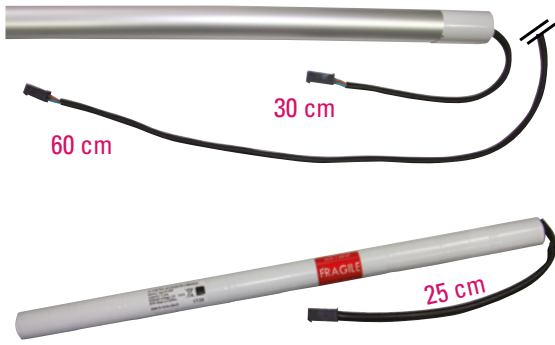

WIDE RANGE OF BATTERIES TO SUIT AT BEST ALL INSTALLATION

- **1 battery stick with alu cover** and its cable of 30cm.
- **1 battery stick with alu cover** and its cable of 60cm.
- **1 naked battery, without alu cover** and its cable of 25cm. Fixing by pop rivet of the specific brackets and elastics to guarantee the fixing.
- **New connectors:** reduced size of the connector to ease the integration inside the side frame.



- **Battery with alu cover:** possibility to connect and disconnect the battery cable easily without opening the roller shutter box. Indeed, once the plastic cover of the stick is removed you can unplug/plug the battery cable.

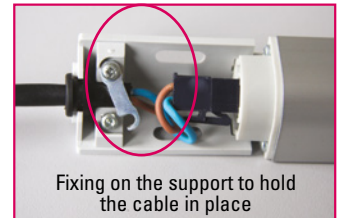
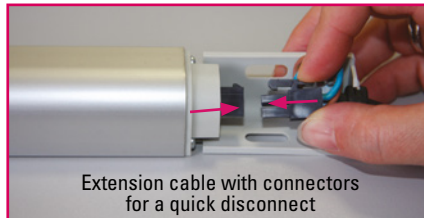
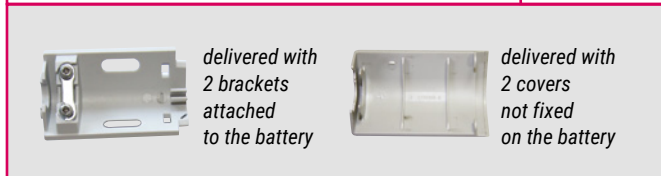

INSTALLATION	ADVANTAGES	RECOMMENDED BATTERIES
Battery outside the roller shutter box: - Between the guide rail and the wall - Behind the Roller Shutter box	Easy access to the battery for resetting the system or replacement of the battery	- Battery with alu cover and its cable of 30cm. Fixing with adhesive or brackets. - Battery with alu cover and its cable of 60cm. Fixing with adhesive or brackets.
Battery inside the roller shutter box	Full integration in factory, nothing to do on site, the roller shutter is ready for use/installation on site.	- Battery with alu cover and its cable of 30cm. Fixing with adhesive or brackets. - Naked battery and its cable of 25cm. Fixing with specific brackets & elastics.

TECHNICAL CHARACTERISTICS

BATTERY Ni-MH
NOMINAL VOLTAGE 12V
CAPACITY 2.2 Ah
AMBIENT TEMPERATURE OF USE from -20°C to +70°C
PROTECTION INDEX IP X4
LIFETIME ± 8 years
DIMENSIONS & WEIGHT naked battery 430 x 23.5mm - 520 gr
 570 x 27 x 27 mm with 0.3 m cable (2-point connector) - 730 gr
 570 x 27 x 27 mm with 0.6 m cable (2-point connector) - 760 gr

REFERENCES

DESCRIPTION	x 1	REFERENCE x 10	X20
Naked battery	9020808	-	9020628
Battery stick + cable 30cm	9020634	9021212	-
Battery stick + cable 60cm	9020635	9021213	-

KIT REFERENCES

PRODUCT	DESCRIPTION	REFERENCE x 1
Battery with cable of 30cm (9020634) + Solar panel with fixing holes (9019032)	SOLAR KIT EXTERIOR C0.3M/1	9021214
Battery with cable of 60cm (9020635) + Solar panel with fixing holes (9019032)	SOLAR KIT EXTERIOR C0.6M/1	9021215

BATTERY ACCESSORIES REFERENCES

SET OF 20 ADHESIVES BATT STICK (length x width = 550 x 15 mm)	9021216 (x1)
SET OF 2 WEDGES BATTERY STICK (dimension: 23 x 19 mm)	9020637 (x1)
 BRACKET WITH ELASTIC TO FIX NAKED BATTERY	9020630 (x40) 9020629 (x200)

2 BLOCKS

To guarantee an alignment of the battery stick on masonry if necessary.



23 x 19 mm

SOLAR PANELS



- Solar panel in resin with fixing holes
- Aesthetic design
- 2 possible fixing:
 - Directly on the roller shutter box by pop rivets
 - On the inclined brackets, on the roller shutter box or on the wall to capture more sun.



- **New solar panel with adhesive** to stick it directly on the roller shutter box without making holes



TECHNICAL CHARACTERISTICS

MATERIAL	resin panel
TYPE OF PANEL	photovoltaics monocristalin
PROTECTION INDEX	IP X4
DELIVERED VOLTAGE	195.8 mA maxi.
POWER	3.2 W
TYPE OF CABLE	Cable of 200mm with 2-point connector type Molex plug (male) and rubber cable-gland for impermeability
DIMENSIONS	470 x 60 x 6 mm
WEIGHT	230 g

REFERENCES

DESCRIPTION	REFERENCE x 1	REFERENCE x 20
Solar panel with holes	9019032	9019031
Solar panel with adhesive	9020627	9020626

KIT REFERENCES

PRODUCT	DESCRIPTION	REFERENCE x 1
Solar panel with fixing holes (9019032) + battery with cable of 30cm (9020634)	SOLAR KIT EXTERIOR C0.3M/1	9021214
Solar panel with fixing holes (9019032) + battery with cable of 60cm (9020635)	SOLAR KIT EXTERIOR C0.6M/1	9021215

SOLAR PANEL ACCESSORIES REFERENCES

PRODUCT	DESCRIPTION	REFERENCE x 1
	Solar panel bracket	9019683
	Extension cable for solar panel (5m)	9019722

BATTERY CHARGER



- **New battery charger with 2 plugs:** one for the EU and another one for the US power supply

TECHNICAL CHARACTERISTICS

CLASS II	double insulation
INTENSITY DELIVERED	800 mA max $\pm 10\%$
DIMENSIONS	118 x 62 x 35 mm
PROTECTION INDEX	IP 30
INPUT VOLTAGE	100-240VCA $\pm 10\%$, 50/60Hz
BATTERY	Ni-MH
CONNECTORS	2-point connector Molex (Male) type

REFERENCES

DESCRIPTION	REFERENCE x 1
Battery charger	9020638

EU

US

OPERATING PRINCIPLE

AUTOSUN is a complete system made up of a solar panel, a battery and a DC radio motor with electronic end-limits.

1 THE SOLAR PANEL

Converts solar energy into electrical energy.

2 THE BATTERY

Stores the energy given by the solar panel.

3 THE MOTOR

Uses the energy of the battery to operate the roller shutter.

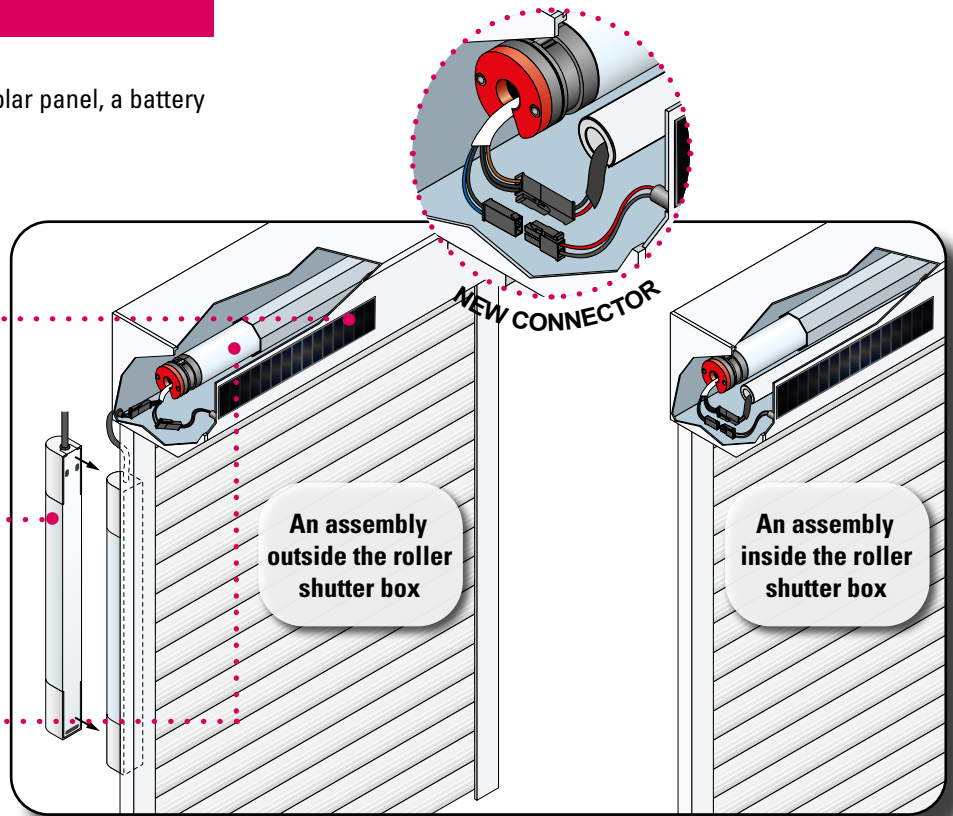

AUTOSUN[®] SOLAR SOLUTION, 100% AUTONOMOUS, WITHOUT WORK

Efficient solution

- Compatible for RENOVATION or NEW installation.
- Powerful Battery: autonomy of **45 days without sun**.
- Solar panel: one solar panel needed whatever the orientation and the motor torque.

Easy integration

- **3 different solutions: to suit all integration:**
 - Naked battery with specific brackets fixed by pop rivets inside the Roller Shutter box
 - Battery in an alu cover: screwed, popped or stuck outside along the guide rail or on the wall
 - Solar panel fixed by pop rivets or adhesives on the roller shutter box or deported on the wall
- Connection of the system (motor, solar panel & battery) by connectors with poka yoke.

Aesthetic solar panel

- Discreet integration on the roller shutter box or on the wall.
- Possibility to deport the solar panel with an extension cable.

A well-equipped roller shutter

- Roller shutter powered by solar energy.
- Radio motor (no wiring).
- Radio SIMU Hz technology, well known on the market.
- Stop on obstacle.
- Frost detection.
- Compatible with LiveIn connected solution and all sequential and functional transmitters.
- Intermediary position.

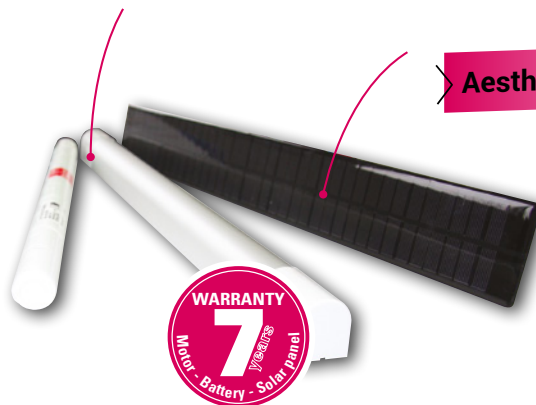

FOR A GOOD INSTALLATION

- Choose the most appropriate motor torque to the dimensions of the roller shutter.
- Load the battery before assembling or installation thanks to the battery charger.
- Make sure that the solar panel is fixed to capture as many sun rays as possible.
- Make sure that there is no shadow on the solar panel (roof, tree...).



KIT REFERENCES (SOLAR PANEL, BATTERY, MOTOR)



The kit is made up of one motor, one solar panel and battery in alu cover (cable 60cm), and is delivered in a single packaging, to meet at best installer needs or for one renovation.

PRODUCT	DESCRIPTION	REFERENCE x 1
T3.5EHZ DC 3/23 motor + battery with cable of 60cm + solar panel	T3.5EHZ 3/23 12V + SOL KIT EXT	2009398
T3.5EHZ DC 6/18 motor + battery with cable of 60cm + solar panel	T3.5EHZ 6/18 12V + SOL KIT EXT	2009399
T3.5EHZ DC 10/12 motor + battery with cable of 60cm + solar panel	T3.5EHZ 10/12 12V + SOL KIT EXT	2009400







AFTER SALES CABLE REFERENCES

PRODUCT	DESCRIPTION	REFERENCE x 1
	MOTOR cable: enable to keep the battery and the solar panel AUTOSUN 1 with one motor AUTOSUN 2	9020481
	BATTERY cable: enable to keep the motor and the solar panel AUTOSUN 1 with one battery AUTOSUN 2	9020639





COMPATIBLE COMMANDS & AUTOMATIC DEVICES

TO PILOT A ROLLER SHUTTER DIRECTLY



 WALL TRANSMITTER MEMORY-HZ	 RADIO WALL TRANSMITTER 1 CHANNEL	 RADIO REMOTE CONTROL 1 CHANNEL	 RADIO SEQUENTIAL TRANSMITTER	 RADIO MICRO-TRANSMITTER	 RADIO REMOTE CONTROL TSA +	 RADIO KEYPAD
---	--	--	--	--	--	--

TO PROGRAM, AUTOMATE AND CENTRALIZE THE SHUTTERS

 RADIO WALL TRANSMITTER 5 CHANNELS	 RADIO REMOTE CONTROL 5 CHANNELS	 RADIO REMOTE CONTROL COLOR MULTI	 RADIO REMOTE CONTROL TIMER MULTI	 RADIO REMOTE CONTROL TIMER EASY
--	---	--	--	--

TO CONTROL ROLLER SHUTTERS FROM A SMARTPHONE OR A TABLET



Liveln2
DEDICATED APP
INCLUDED
FOR ISO AND ANDROID





A DEDICATED WEBSITE
www.livein.simu.com

NEW Liveln2 BOX + Dedicated App.

ALL THE INFO AVAILABLE ONLINE FOR YOUR CUSTOMER TO FIND OUT ALL ABOUT THE SOLUTION.

--	--	--	--	--

Realization SIMU - 02/22 - SIMU SAS - capital 5 000 000 euros. RCS Vesoul 425 650 080. This document is not legally binding. We reserve ourselves the right to make any useful modification in order to constantly develop and improve our tender. SIMU shall not be held responsible for misuse by non-professionals.